

CHEH3647

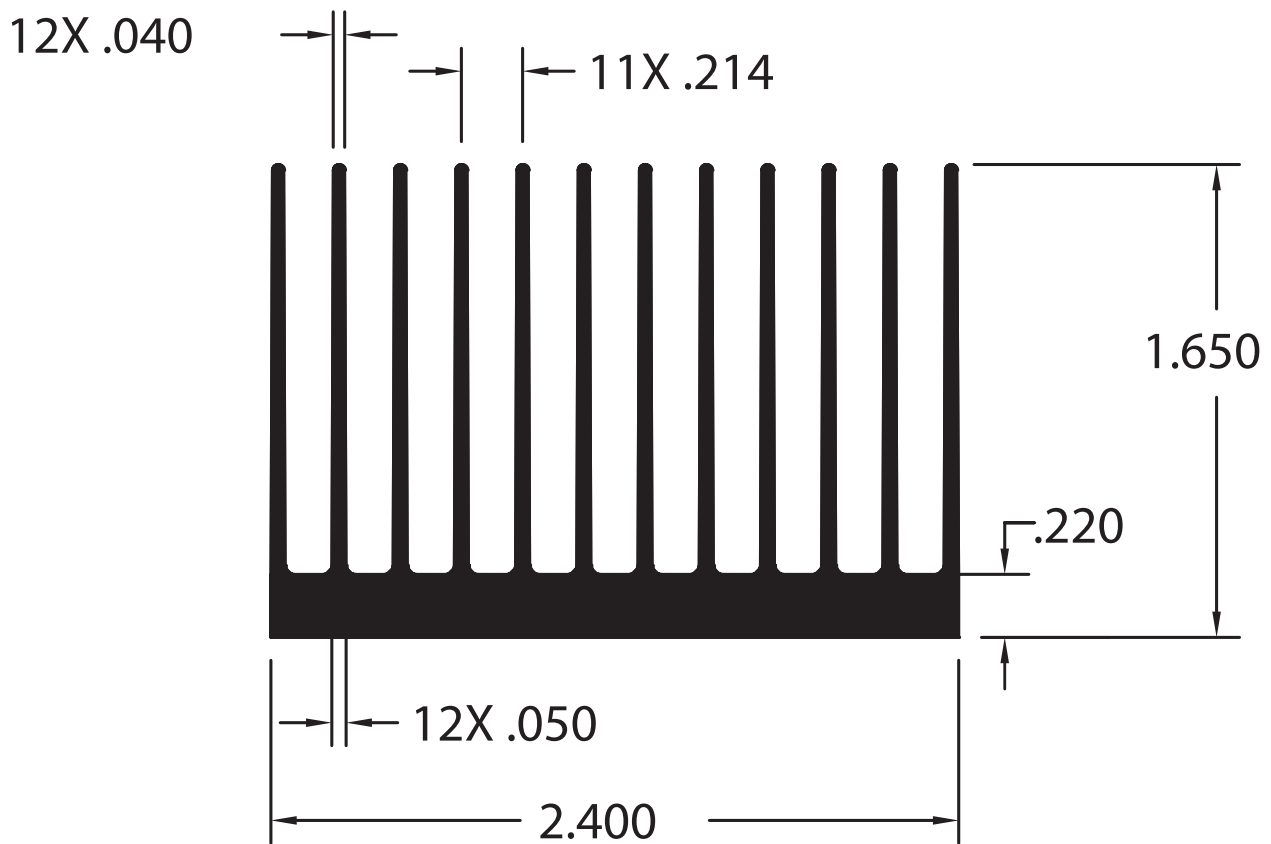

Per. 38.49IN²/IN

Wt. 1.56 LB/FT

1.3 °C/W3"