

CHEH0031

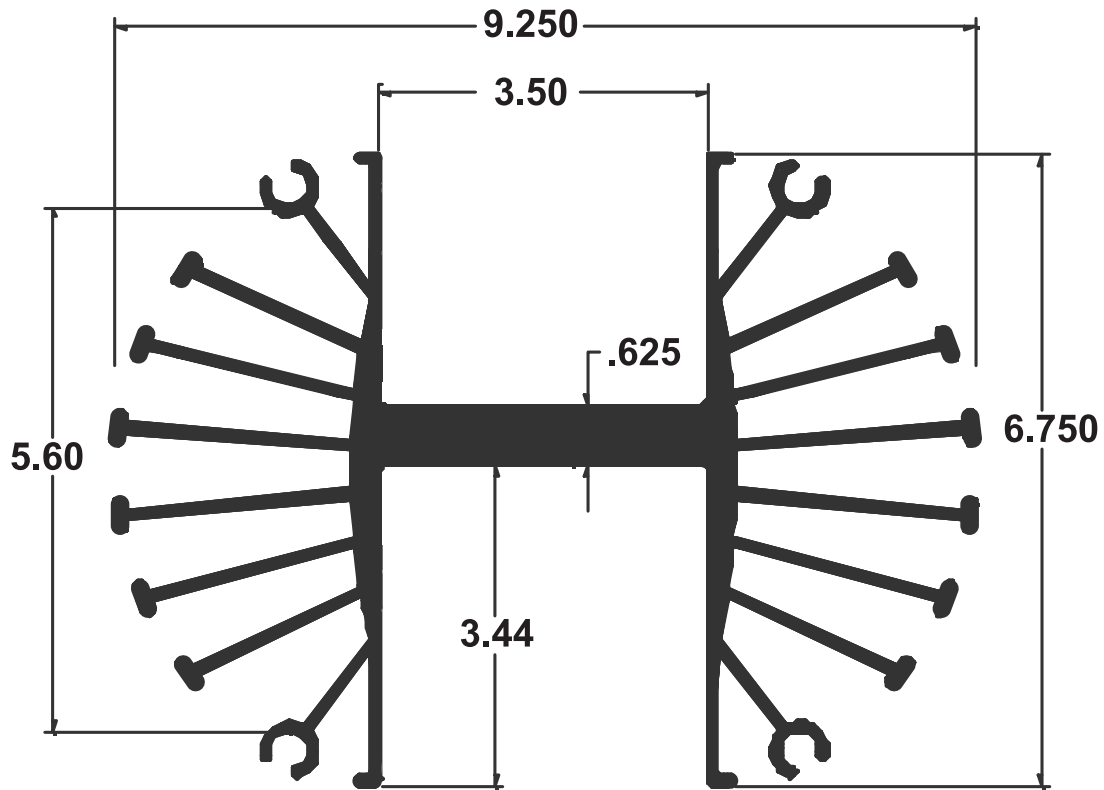

Per. $118.25 \text{ IN}^2 / \text{IN}$

Wt. 9.6 LB/FT

0.4° C/W/3"