



Mounting Instructions for MTP Modules

By Kevin Liu

This application note introduces Vishay's MTP rectifier-switch modules and discusses the assembly and PCB issues involved in their use.

MTP modules are designed to provide reliable performance in rugged 20 A to 100 A industrial applications. A single housing is used to integrate power components, providing higher power density. Various die selections are available in several configurations. An integrated thermal sensor is also offered as an option.



Fig. 1 - Example of MTP Module (solder pin)



Fig. 2 - Example of MTP Module (press fit)

INTRODUCTION

Vishay's MTP modules are distinguished by these key features:

- Fully isolated
- Compact and easy to mount
- PressFit pins locking technology. Patent # US.263.820.B2
- Low profile package suitable for assembly on PCB
- Low junction to case thermal resistance

These attributes allow MTP modules to fit into existing assembly processes using standard reflow profiles or press fit mechanical contact.

Important factors in the assembly process are:

- Heatsink design
- PCB design
- Power leads size / area
- Distance from adjacent heating parts
- Solder alloy choice
- Reflow profile
- Protection against electrostatic discharge (ESD)

Recommendations for each of these items and requirements for mounting MTP modules to the PCB are discussed in the following sections.

ESD PROTECTION

IGBT, MOSFET, and diode modules are sensitive to ESD. All MTP modules are ESD-protected during shipment with an antistatic tube. Anyone handling or working with the modules during the assembly process must wear a conductive grounded wristband.

HEATSINK SPECIFICATION

The contact surface of the heatsink must be flat, with a recommended tolerance of < 0.03 mm (< 1.18 mils) and a levelling depth of < 0.02 mm (< 0.79 mils), according to DIN/ISO 1302. In general, a milled or machined surface is satisfactory if prepared with tools in good working condition. The heatsink mounting surface must be clean, with no dirt, corrosion, or surface oxide. It is very important to keep the mounting surface free from particles exceeding 0.05 mm (2 mils) in thickness.

Mounting Instructions for MTP Modules

MOUNTING OPERATION

Inspect the module to ensure that the contact surface of the base is clean, and that there are no lumps or bulges on the baseplate that could damage the base or reduce heat transfer across the surfaces.

Make a uniform coat on the heatsink mounting surfaces or on module baseplate with a good quality thermal compound is recommended; direct application with a roller or spatula is also suitable. The test conditions for thermal resistance values on the datasheet specify a uniform layer of thermal compound with a thickness in the range of 0.08 mm (3.1 mils) to 0.1 mm (4 mils). The thermal conductivity of the compound should be not less than 0.5 W/mK.

Bolt the module to the heatsink using the two fixing holes. An even amount of torque should be applied for each individual mounting screw. An M5 screw should be used with lock washers. A torque wrench, accurate in the specified range, must be used to achieve optimum results when mounting the module. The first mounting screw should be tightened to one third of the recommended torque; the second screw should then be tightened to the same torque. Full tightening of both the screws can then be completed applying the recommended torque (see data in bulletins). Over-tightening the mounting screw may result in deformation of the package, which would increase the thermal resistance and damage the semiconductors. After a period of three hours, check the torque with a final tightening in opposite sequence to allow the spread of the compound.

The module base-plate planarity can vary from slightly concave to convex with convexity typically 0.05 mm (2 mils) when measured between the two fixing holes. This provides for an optimal contact area with the heatsink (Fig. 3).

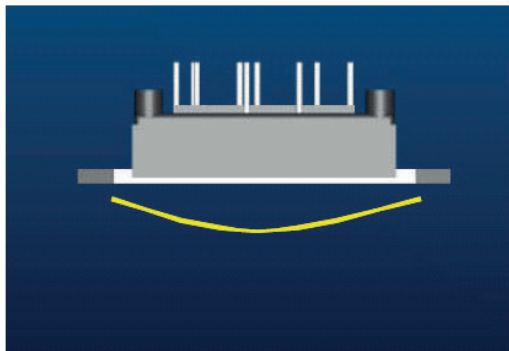

Fig. 3 - Description of “Module Convexity”

SOLDER TO PCB

The PCB must be designed with appropriate tolerances on its hole diameters.

Soldering operations must be done so as to avoid inducing any mechanical stress from pulling or tensioning the module pins. The module stand-off can be used to help align the PCB and keep proper distance. MTP modules can be soldered to the PCB using hand iron or wave soldering processes. To prevent overheating of the device, we suggest the soldering time not exceed 8 s to 10 s at a temperature of 260 °C. The mounting of the module on the heatsink can be done either before or after soldering the module pins onto the PCB.

If the module needs to be removed from the PCB, the first step is to unscrew it from the heatsink, followed by gentle movement of the module to separate it from the heatsink. Thermal grease will remain both on the heatsink surface and on the bottom baseplate surface.

PRESS FIT TO PCB

The solder-free press fit method can be used as an alternative for contacting MTP pins to the PCB. The major advantages of this method are the elimination of solder reflow and its related temperature profile.

The majority of standard FR4 PCB boards can be used with no special requirement in terms of dimension and number of layers. Vishay tested both FR4 125 and FR4 180 PCB models.

MTP pins have been designed with the size and shape required to fit into the PCB holes during the assembly process. The contact between the pin and PCB hole will result in a very low contact resistance (less than 500 μΩ).

Double-sided or multilayer PCBs according to IEC 60249 can be used.

As per IEC 60352-5 the PCB material should be defined with following specifications;

- PCB hole diameter: 1.12 mm - 1.15 mm
- Copper thickness in hole: 25 μm - 50 μm
- Metallization in hole: < 15 μm
- End hole diameter (after hole plating): 0.94 mm - 1.09 mm
- Copper thickness of conductors: 35 μm to 400 μm (typical 70 μm to 105 μm)
- Metallization of circuit board: tin (chemical)
- Metallization of pin: tin (galvanic)

Mounting Instructions for MTP Modules

Due to the wide variety of PCB construction methods and designs available on the market, there are multiple solutions that might be adopted by MTP module end users. Vishay strongly suggests adhering to the specifications described above, which have been used to test and qualify MTP press-fit pin solutions. In principle, other methods to get tin plating, like HAL, might be used if they can guarantee the needed tolerances in layer thickness.

We do not recommend reusing an MTP device after it has been de-mounted from the PCB. Even if tests conducted during qualification showed no degradation of the press-fit pin contact or variation of the needed press-in force after

three cycles (mount/de-mount) of the same module on three different PCBs with 25 mm/s insertion speeds, if a MTP module is to be reused, we suggest soldering the connecting pins.

It is possible to utilize the same PCB after de-mounting from the MTP module up to three times. The tests conducted during qualification showed no degradation of the PCB hole contact and variation of the needed press-in and pull-out forces after three cycles (mount/de-mount) of different modules on the same PCB with 25 mm/s insertion speed. However, special attention must be taken to avoid pin damage and bending during the mount/de-mount process.

PRESS-IN TOOLS

The pin-to-PCB press-in operation has been defined and validated by using the tools shown in Fig. 4. We suggest adopting a similar approach when selecting the press-in to be installed at the end user manufacturing floor.

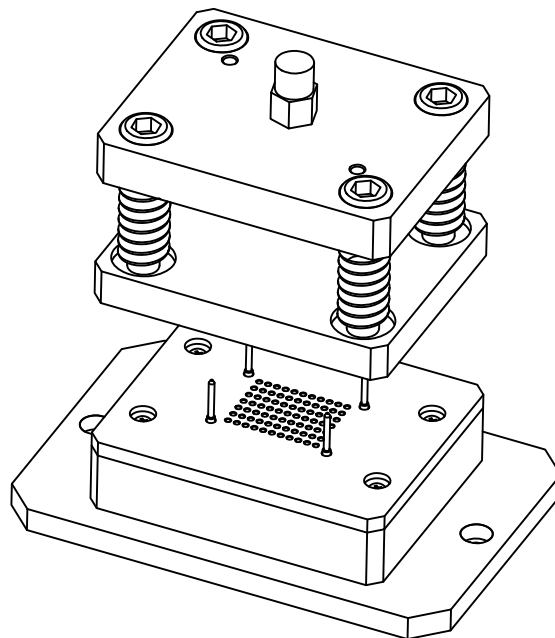

Fig. 4 - The tool for PCB module press-in

Mounting Instructions for MTP Modules



Fig. 5 - Photo of the tool for PCB module press-in

The bottom side of the press tool keeps the PCB fixed, while the top side moves and applies force directly onto the module baseplate. Special settings have to be prepared when simultaneously mounting more than one MTP module on the same PCB.

PRESS-IN

Based on the results of the qualification tests we suggest mounting the MTP module on the PCB with the following conditions:

Insertion speed in the range: 25 mm/min. to 50 mm/min. (as suggested also in IEC 60352-5)

- Minimum force to press-in each pin is 35 N
- Maximum force to press-in each pin is 90 N
- Therefore, the press-in force for a 20 pin MTP module should be in the range 0.7 kN to 1.8 kN

The press-in procedure using a semiautomatic machine is illustrated below

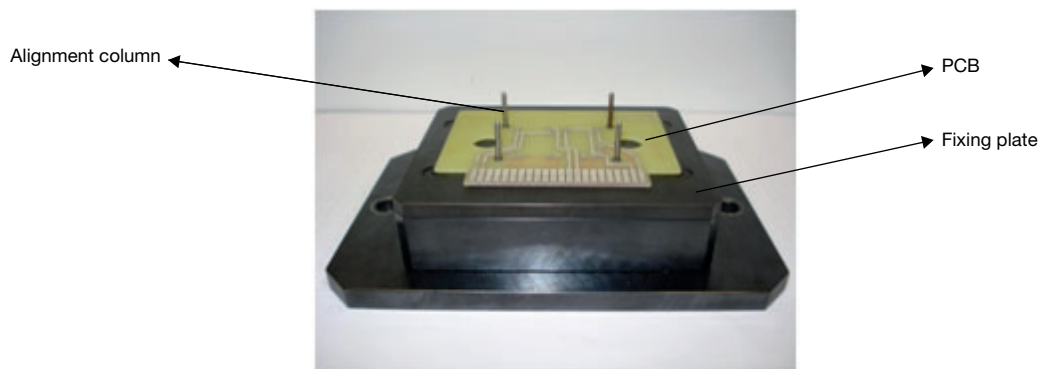

Fig. 6 - Step 1: Put the PCB on the assistant tool

Mounting Instructions for MTP Modules

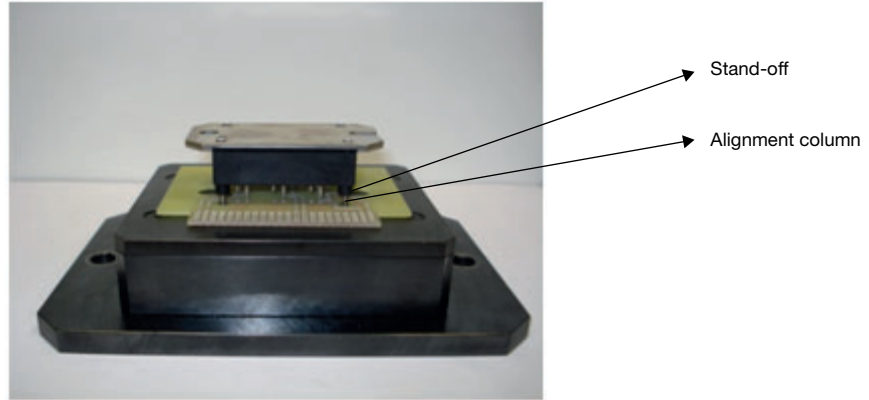

Fig. 7 - Step 2: Put the MTP module on the PCB and make sure the alignment column is aligned into stand-off



Fig. 8 - Step 3: Start the semiautomatic machine to press the press fit module into the PCB, making sure there is no gap between the standoff and the PCB

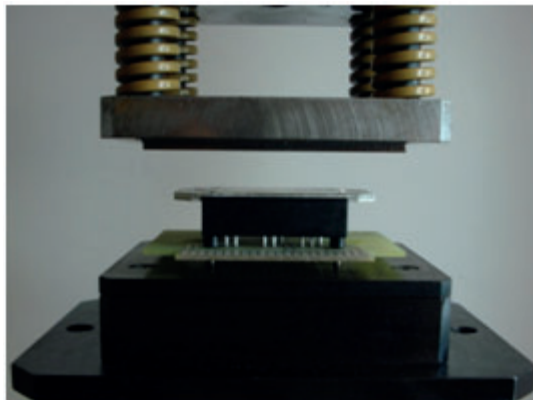

Fig. 9 - Step 4: Stop the machine and press-in is finished

Mounting Instructions for MTP Modules

PRESS-OUT

The force to be applied in order to press-out the single pin is at least 20 N. Therefore, the force needed to press-out a 20-pin MTP module is 0.4 kN.

To press-out the MTP module from the PCB, we suggest using the tool and pushing directly by contacting the pin's edge. It is not recommended to remove the device from the PCB by pulling the baseplate. The press-out setup tool is illustrated below.

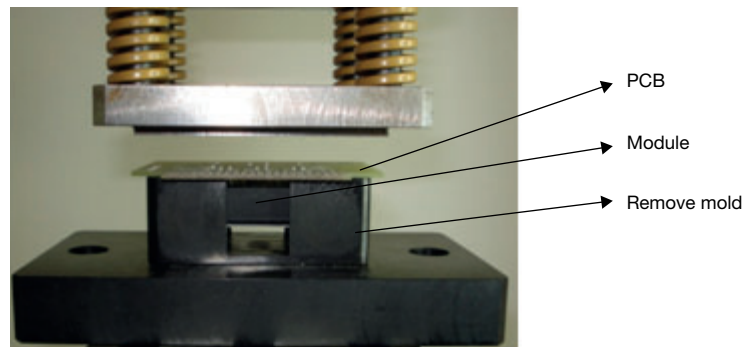

Fig. 10

MOUNTING A PCB TO THE MODULE

The MTP module housing has been designed with four stand-off lids. They can be used to tighten the PCB to the module body by adding screws. Fig. 11 shows a schematic of a PCB connected to a MTP through screws tightened into the module's stand-offs.

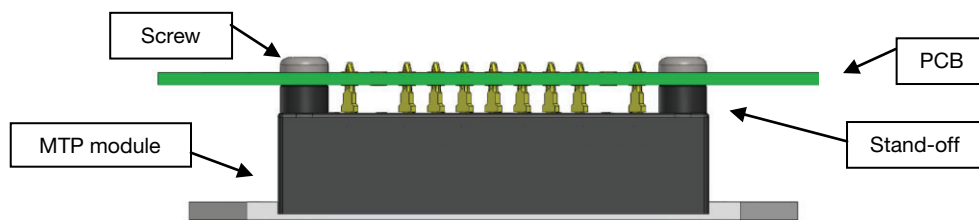

Fig. 11

Screwing into a plastic cavity is a delicate operation, and care has to be taken to avoid stand-off damage. We suggest using M2.5 x 10 self-tapping screws, in accordance with the PCB thickness, to avoid touching the bottom surface of the stand-off cavity. The screws will self-thread into the stand-off cavity. The vertical position of the screw must also be maintained to prevent lateral insertion. We also suggest mounting the screws in a crosswise sequence. For example, if the fixing holes are 1, 2, 3, and 4 in a clockwise or counter-clockwise sequence, then we suggest mounting the screws by the sequence 1 and 3, then 2 and 4. In addition, the screwdriver used should have a slow rotating speed. Typical mounting torque is 0.45 Nm \pm 10 %. Do not exceed 1 Nm to avoid screw/plastic damage.

END OF LIFE MODULE WASTE DISPOSAL RECOMMENDATION

Corporate social responsibility is more and more important for the environment protection, Vishay is certified by ISO 140001 and Vishay modules are always compliant with the Restriction of Hazardous Substances in Electrical and Electronic Equipment (RoHS) directive.

We recommend that the end of life modules (include components of the modules) shall be segregated by hazardous and collected in a labeled container (refer to CER code # 16.02.16) which should be put in a designated place.